

THIS DOCUMENT MUST NOT BE COPIED WITHOUT OUR WRITTEN PERMISSION, AND THE CONTENTS THEREOF MUST NOT BE IMPARTED TO A THIRD PARTY NOR BE USED FOR ANY UNAUTHORIZED PURPOSE. CONTRAVENTION WILL BE PROSECUTED.

REVISIONS			
REV.	DESCRIPTION	DATE	SIGNATURE
A		2019-07-24	JA

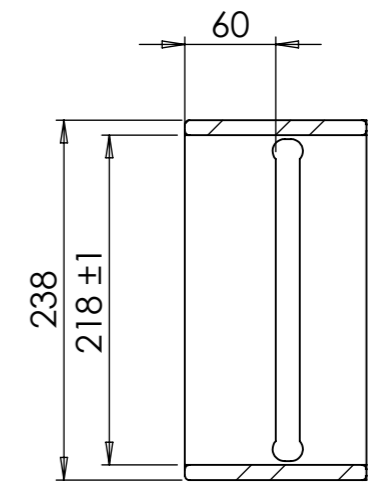

SECTION A-A

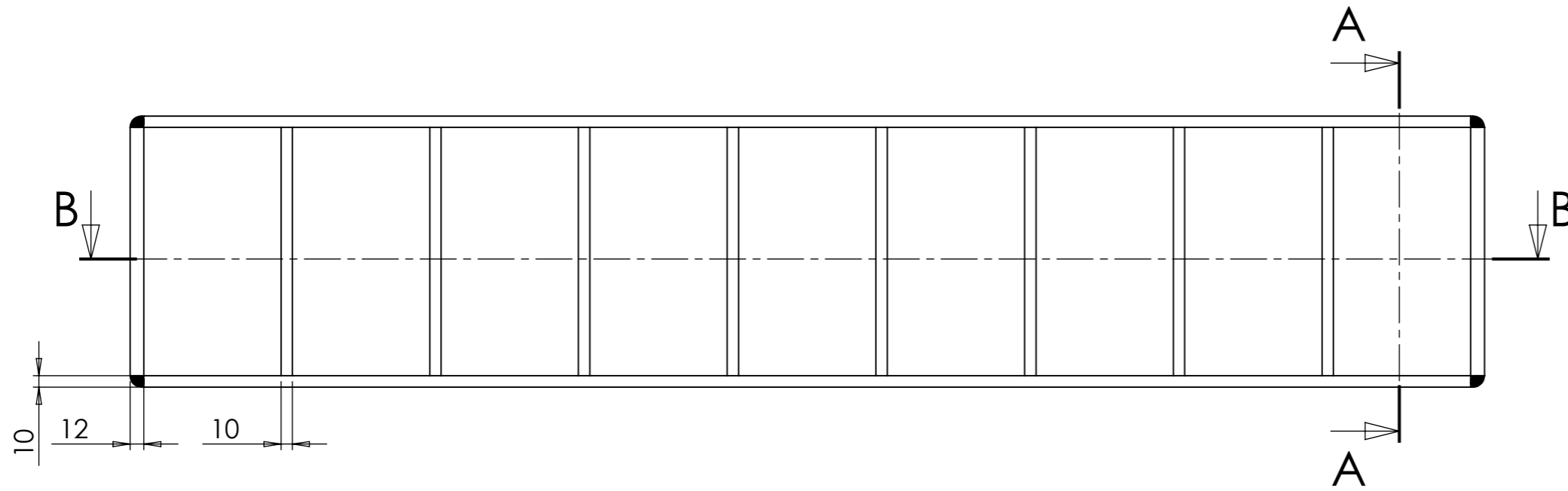
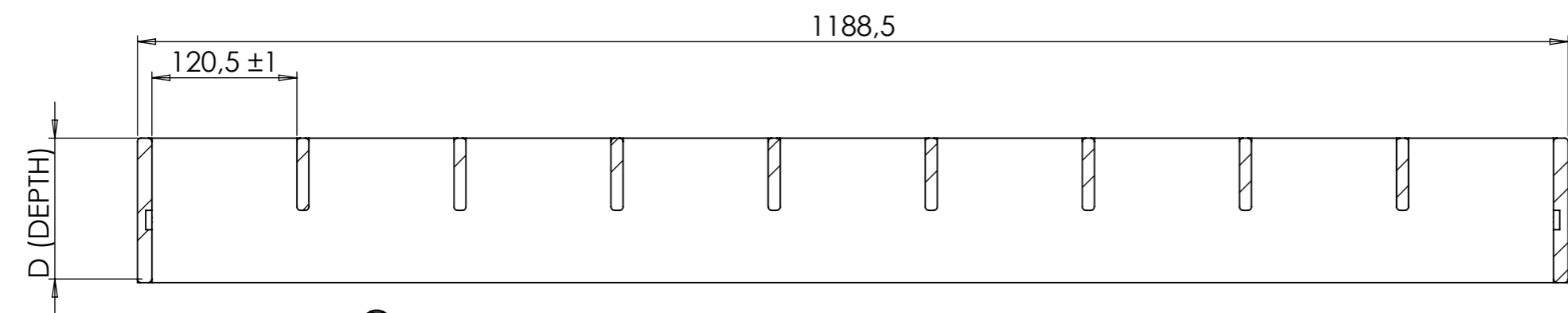

SECTION B-B

FRAME TYPE	D (DEPTH)
TYPE 1	120
TYPE 2	150
TYPE 3	200

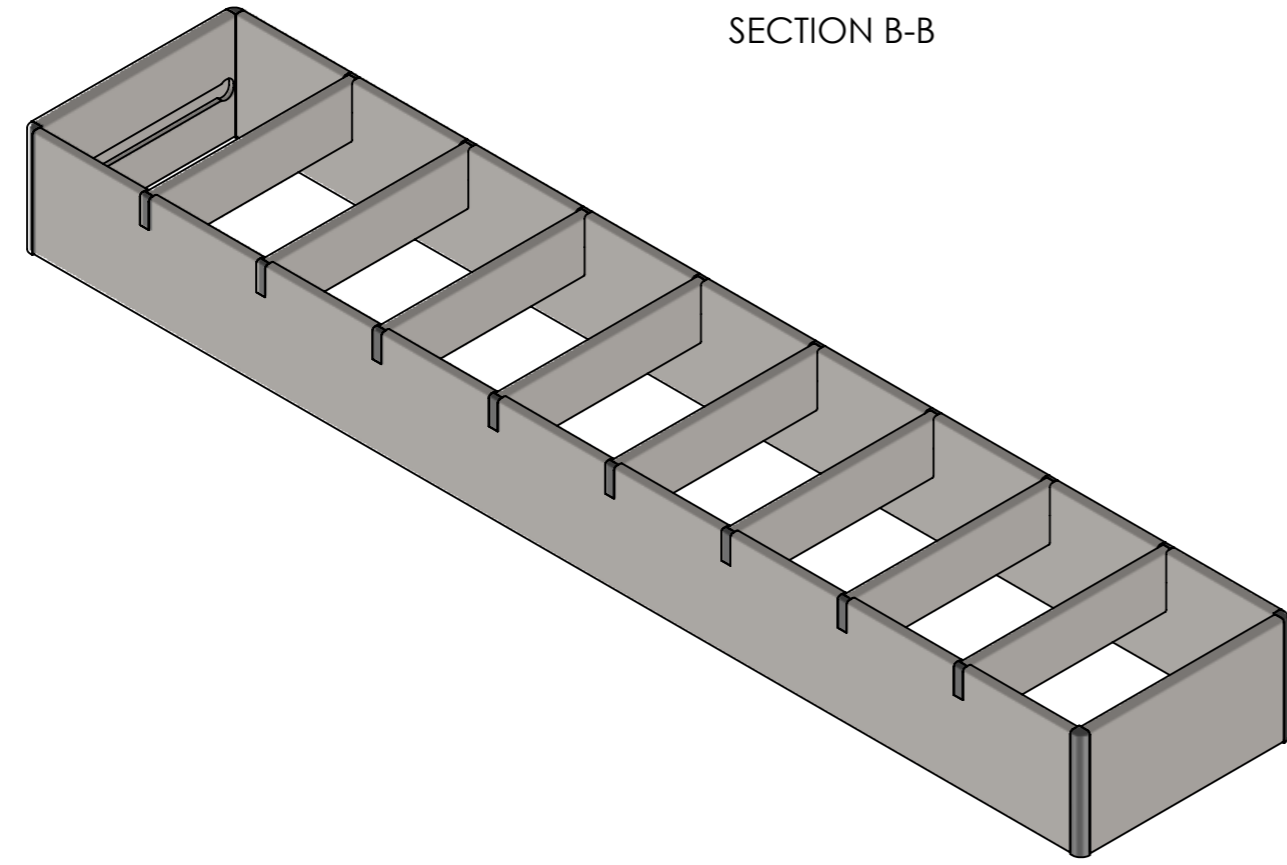

Ritad Drawn	Kontr. Check	Granskad Reviewed	Godkänd Approved	Tolerans där ej annat anges Tolerance unless otherwise not stated. ISO 13920-BF	Smst. nr. Assembly drawing no.	Ersätter Replaces	E
JA	JA	JF	BJ	Ytjämnhet där ej annat anges. Surface finish otherwise not stated.	Material	Ersatt av Replaced of	Vikt Weight
190724	190725	190809	190812	<p>RGSK-6x9 INFORMATION DRAWING</p>		<p>Alla mått och uppgifter avser färdig produkt om ej annat anges All measures and other information refer to finished products unless otherwise not stated.</p>	
						Kund ordernr. Customer order no.	
						1190318	A