

Work Installation instruction.

SR – 25-200
SR INS-2025-Rev. A

Tools and Materials Required:

- Spanner
- MCT Brattberg Lubricant
- Stanley Knife or Razorblade
- Measuring Tape
- Cleaning Cloth

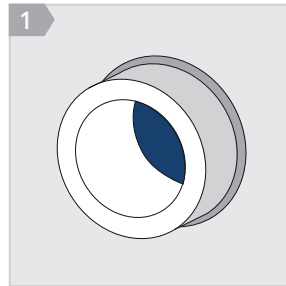
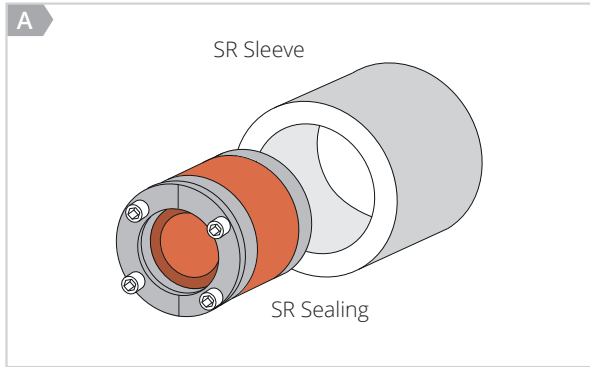

If the sleeve is not prepared, please see MCT Brattberg welding guide.

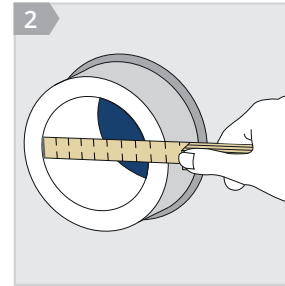

Verify the sleeve/pipe aperture internal dimensions in within SR tolerance. Clean the inside of the sleeve.

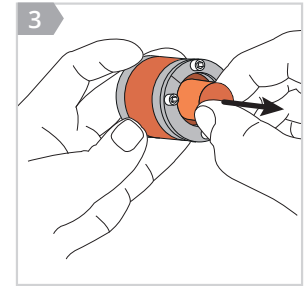

Modify the SR sealing by removing the core and any excess rings as needed, allowing the cable or pipe to pass through.

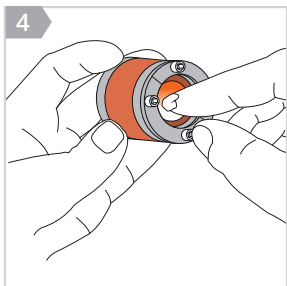

Lubricate the inner sealing surfaces and the cable or pipe using MCT Brattberg Lubricant.

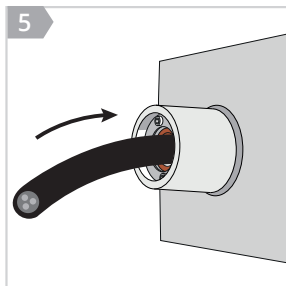

Install the sealing into the SR housing and guide the cable or pipe through it.

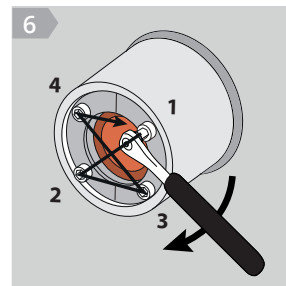

Gradually tighten the screws in a crosswise pattern until the cable or pipe is securely fixed and the rubber seal protrudes slightly.

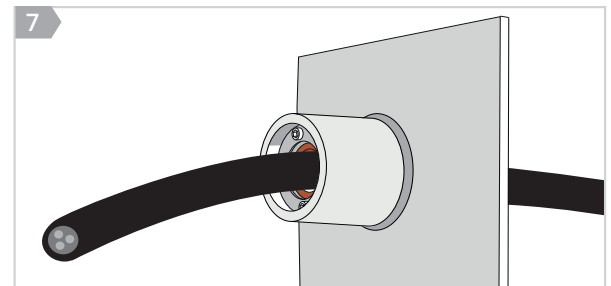

Retrofit installation

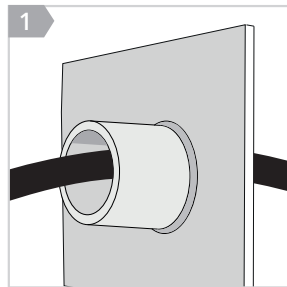

If the cable or pipe is already installed, open the SR sealing and place it over the cable or pipe.

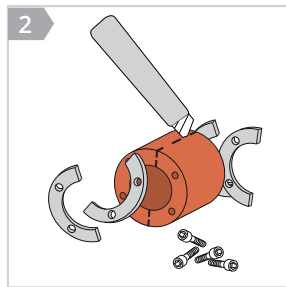

Open the SR sealing and place it over the service. Use pliers if necessary to separate the hardware. Cut the seal with Stanley knife or razorblade.

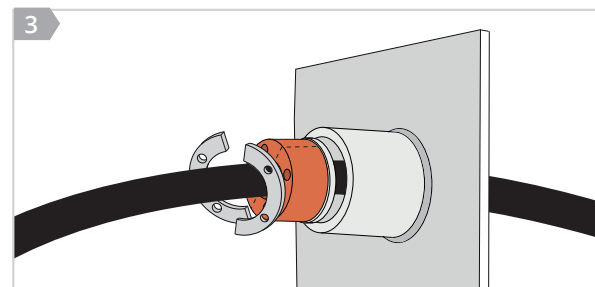

Note: Verifying the installation of the seal with a torque value is not recommended. The value change depending on the ambient temperature and amount/type of service through the sealing. If verification is required, please see maximum value for each type of fixing below.

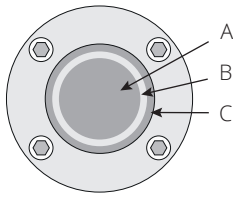

SR SIZE	CABLE ENTRIES	Plug Range		Ring Range		Fixings		Max Torque	
		A		B		C			
		Min	Max	Min	Max	Min	Max	Nm	
25	1	4	6	6	12	-	-	M4	3.2
38	2	12	18	18	24	-	-	M4	3.2
38-2	4	6	9	9	15	-	-	M6	11.2
38-3	1	6	12	-	-	-	-	M4	3.2
49	1	20	26	26	32	-	-	M5	6.6
62	1	30	36	36	42	-	-	M5	6.6
77	1	40	46	46	52	-	-	M5	6.6
102	1	50	57	57	64	64	70	M6	11.2
125	1	65	72	72	78	78	85	M6	11.2
150	1	85	87	87	94	94	100	M8	27.5

Disclaimer SR

- For optimum reliability, wait 48 hours or longer after installation before exposing the cables/pipes to strain or pressure.
- Cables/pipes should be parallel to the sleeve/aperture.
- Cable/pipe with a considerable weight needs to be supported to prevent damage or subsidence to the seal.
- Approvals or certificates may include amendments or limitations related to this application.
- A seal with core is spare capacity.
- Latest information can be found on MCTBrattberg.com

Disclaimer:

This instruction guide may be subject to revision and changes due to development and changes of the material and products. The data is derived from tests and experience. If not stated as minimum values, the data is average data and should be treated as such. Calculations should be verified by actual tests. The data is furnished without liability for the company and does not constitute a warranty or representation in respect of the material or its use. The company reserves the right to release new instruction guides in replacement.

Installation limitations, such as maximum cable or pipe sizes and applicable configurations, are defined in the relevant Type Approval Certificate (TAC). These instructions and drawings shall be read in conjunction with the applicable certificate to ensure compliance with all applicable approval certificates, rules, and project-specific requirements.